



 **ELEGANCE**

OUTDOOR PORCELAIN

2024 Collection

**OUTDOOR SPIRIT,
RESISTANCE AND VERSATILITY:
THESE ARE JUST A FEW OF THE FEATURES
OF 20 MM THICK PORCELAIN
STONEWARE.**



PORCELAIN 2CM PAVER is ideal for public and private outdoor flooring and stands out for its exceptional technical performance.

A perfectly square and monocaliber porcelain stoneware slab with a 20 mm thickness that features surface finishes with high antislip performance (R11 A+B+C), with a wide range of special pieces that create visual continuity between indoor and outdoor spaces, making them perfect for swimming pools and wellness centres.



BENEFITS



HIGH RESISTANCE TO BREAKING LOADS AND STRESS



HIGH NON-SLIP PERFORMANCE: R11 A+B+C



EASY TO CLEAN



HIGH RESISTANCE TO FROST AND FIRE

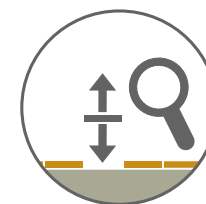

EASY TO INSTALL, REMOVE AND REPOSITION*



RESISTANCE TO THE WEATHERING ELEMENTS AND THERMAL SHOCK



RESISTANCE TO SALT AND INALTERABILITY OVER TIME

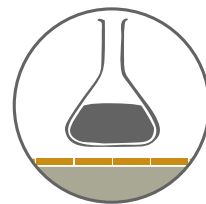

RESISTANT TO ACIDS

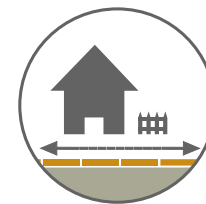

PERFECT CONTINUITY BETWEEN INDOOR AND OUTDOOR AREAS



REUSABLE

□ IT DOES NOT REQUIRE A SPECIALIZED TILE LAYER (IN CASE OF DRY INSTALLATION) NEITHER THE USE OF GLUES AND GROUTS (IN CASE OF DRY OR RAISED INSTALLATION)

INSTALLATION SOLUTIONS

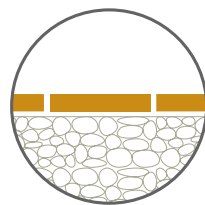

DRY INSTALLATION ON GRAVEL

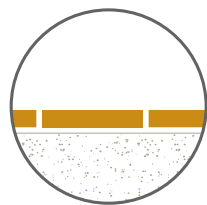

DRY INSTALLATION ON SAND

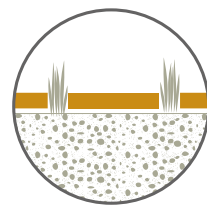

DRY INSTALLATION ON GRASS

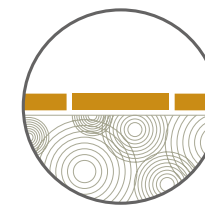

TRADITIONAL INSTALLATION ON SCREEDS

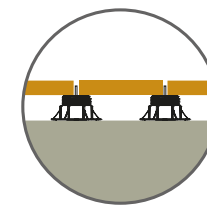

RAISED INSTALLATION ON SUPPORTS



INTENDED USES

PORCELAIN 2CM PAVER'S MAIN FEATURES MAKE IT THE IDEAL SOLUTION FOR ANY TYPE OF PUBLIC AND PRIVATE

OUTDOOR FLOORING. PORCELAIN 2CM PAVER REPRESENTS THE BEST SOLUTION FOR:

- WALKWAYS IN GARDENS OR ON BEACHES
- TERRACES AND BALCONIES

- PATIOS, COURTYARDS, SWIMMING POOL EDGES, AND WELLNESS CENTRES
- DRIVE-OVER PATHWAYS

COLORS

20"X40"

WHITE



20"x40"

SMOKEY



20"x40"

MOON



20"x40"

DESERT



20"x40"

DUST



20"x40"

DARK



20"x40"

SUNSET



20"x40"

ALPINE



20"x40"

SAND



20"x40"

SILVER



20"x40"

MARS



20"x40"

MINERAL



20"x40"

FOSSIL



20"x40"



MOON



WHITE

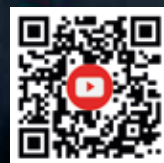
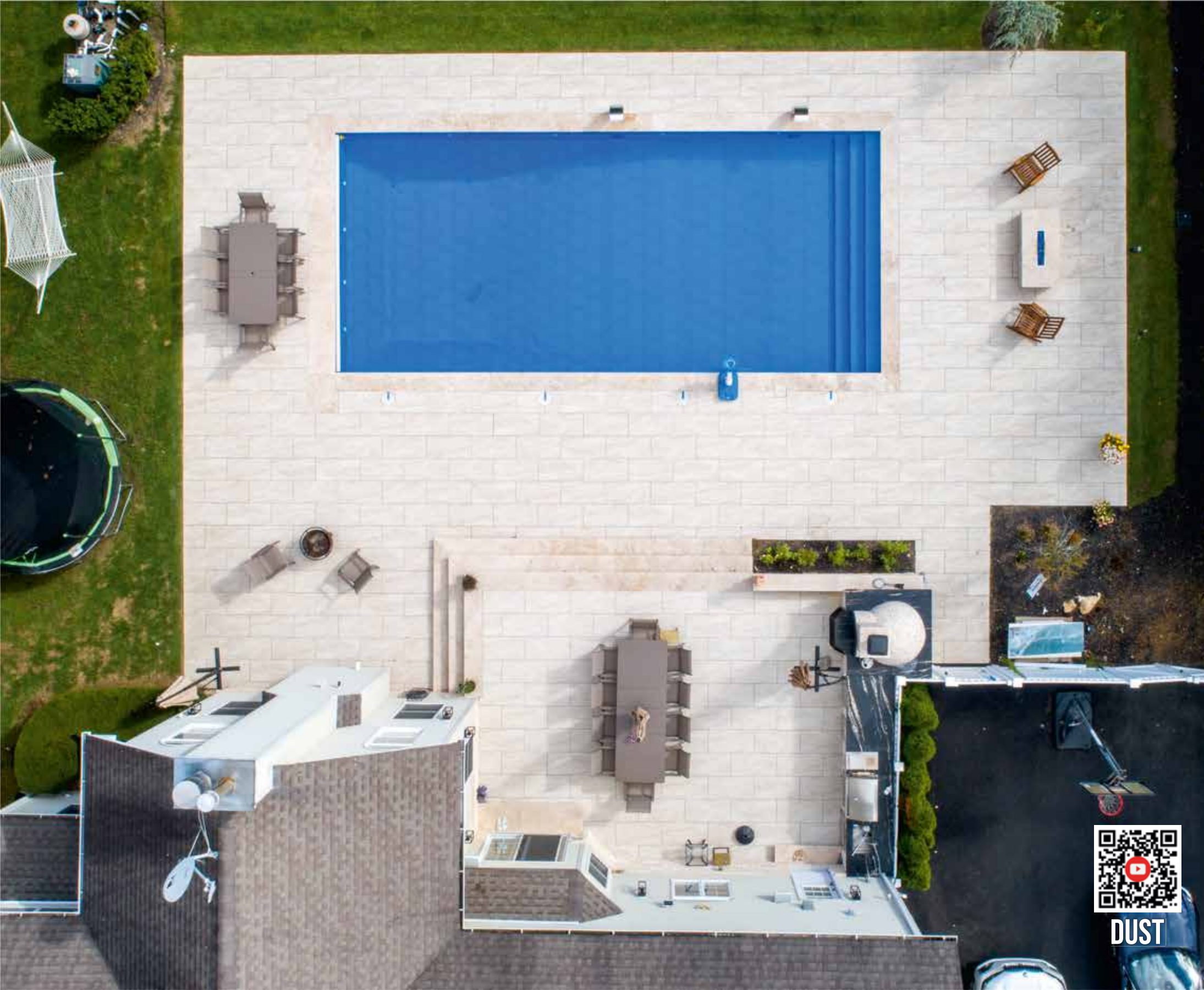

DUST

COLORS

MINI MODULAR PATTERN 3 SIZES

These sizes can be purchased individually, allowing for both patterned and single-size selections.

SANDSTONE RECTIFIED



18"x36"



24"x24"



12"x24"



Modular Pattern

ASH RECTIFIED



18"x36"



24"x24"



12"x24"



Modular Pattern

1 set includes:

- ① 18"x36"x3/4" (1pc)
- ② 24"x24"x3/4" (1pc)
- ③ 12"x24"x3/4" (1pc)

Modular Pattern 3 Sizes Format

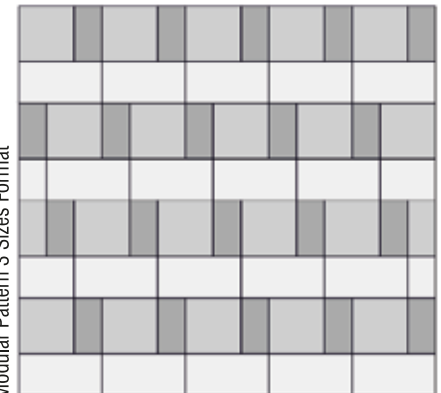



COLORS

MINI MODULAR PATTERN 3 SIZES

These sizes can be purchased individually, allowing for both patterned and single-size selections.

COAL RECTIFIED



18"x36"



24"x24"



12"x24"



Modular Pattern

METAL RECTIFIED



18"x36"



24"x24"



12"x24"



Modular Pattern

1 set includes:

- ❶ 18"x36"x3/4" (1pc)
- ❷ 24"x24"x3/4" (1pc)
- ❸ 12"x24"x3/4" (1pc)

Modular Pattern 3 Sizes Format

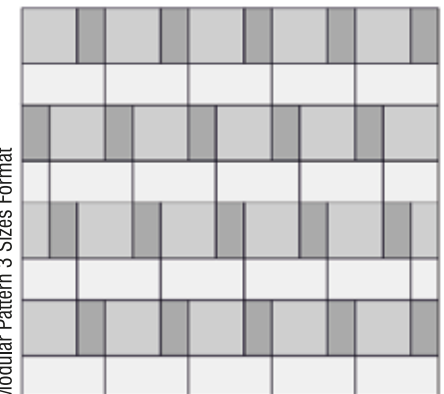



COLORS

MODULAR PATTERN 3 SIZES

1 set is 18 sq ft:

- ❶ 24"x36"x3/4" (2pcs) = 66.67%
- ❷ 24"x24"x3/4" (1pc) = 22.22%
- ❸ 12"x24"x3/4" (1pc) = 11.11%

Modular Pattern 3 Sizes Format



DARK GREY



12"x24"



24"x24"



24"x36"

LIGHT GREY



12"x24"



24"x24"



24"x36"



Modular Pattern



Modular Pattern

COLORS

MODULAR PATTERN 3 SIZES

1 set is 18 sq ft:

- ❶ 24"x36"x3/4" (2pcs) = 66.67%
- ❷ 24"x24"x3/4" (1pc) = 22.22%
- ❸ 12"x24"x3/4" (1pc) = 11.11%

Modular Pattern 3 Sizes Format



HONEY



12"x24"



24"x24"



24"x36"



Modular Pattern



CARAMEL



12"x24"



24"x24"



24"x36"



Modular Pattern



COLORS

MODULAR PATTERN 3 SIZES

1 set is 18 sq ft:

- ❶ 24"x36"x3/4" (2pcs) = 66.67%
- ❷ 24"x24"x3/4" (1pc) = 22.22%
- ❸ 12"x24"x3/4" (1pc) = 11.11%

Modular Pattern 3 Sizes Format



MILK



12"x24"



24"x36"



24"x24"



Modular Pattern

STORM



12"x24"



24"x36"



24"x24"



Modular Pattern



COLORS

MODULAR PATTERN 3 SIZES

1 set is 18 sq ft:

- ① 24"x36"x3/4" (2pcs) = 66.67%
- ② 24"x24"x3/4" (1pc) = 22.22%
- ③ 12"x24"x3/4" (1pc) = 11.11%

Modular Pattern 3 Sizes Format



BLUESTONE



12"x24"



24"x24"



24"x36"



Modular Pattern

URBAN WHITE



12"x24"



24"x24"



24"x36"



Modular Pattern



LIGHT GREY



HONEY MODULAR PATTERN



COLORS 24"X24"

LIGHT GREY



24"x24"

DARK GREY



24"x24"

BLUESTONE



24"x24"

TAUPE



24"x24"

INOX



24"x24"

METAL



24"x24"

SANDSTONE



24"x24"

SOFT CREAM



24"x24"

ASH



24"x24"

COAL

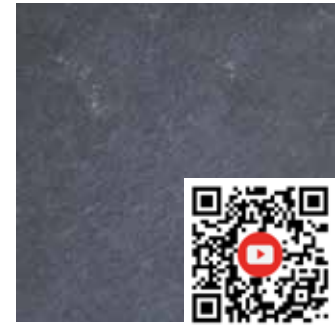

24"x24"

PIETRA GREY



24"x24"

RUSTIC GRIGIO



24"x24"

POCONO



24"x24"

FORGE



24"x24"

CARAMEL



24"x24"

HONEY



24"x24"

MILK



24"x24"

COLORS 24"X24"

STORM



24"x24"

NEST



24"x24"

BURNT



24"x24"

ROCKY



24"x24"

FLAKE



24"x24"

PHILLY GRAY



24"x24"

PHILLY TAUPE



24"x24"

PHILLY WHITE



24"x24"

PHILLY BEIGE IN STOCK IN ITALY



24"x24"

URBAN WHITE



24"x24"

KEYSTONE FOG



24"x24"

KEYSTONE PURE



24"x24"

BASALTO GREY



24"x24"

IN STOCK IN ITALY

BASALTO RED



24"x24"

IN STOCK IN ITALY

BASALTO BLACK



24"x24"

IN STOCK IN ITALY





NEST

COLORS CEMENT LOOK

32"X32"

ANTRACITE



Rectified 32"x32"

GRIGIO



Rectified 32"x32"

AVORIO



Rectified 32"x32"



INOX



SPACE DARK

IN STOCK IN ITALY



Rectified 32"x32"



AVORIO 32"X32"



INOX

COLORS

WOODTIME

ALPIN



16"x48"

NEW



8"x48"

NEW

CLAY



16"x48"

NEW



8"x48"

NEW

TIMBER



16"x48"

NEW



8"x48"

NEW



COLORS

24"X36"

LIGHT GREY



24"X36"

BLUESTONE



24"X36"

DARK GREY



24"X36"

URBAN WHITE



24"X36"

BASALTO GREY

IN STOCK IN ITALY



24"X36"

BASALTO RED

IN STOCK IN ITALY



24"X36"

BASALTO BLACK

IN STOCK IN ITALY



24"X36"



LIGHT GREY



URBAN WHITE

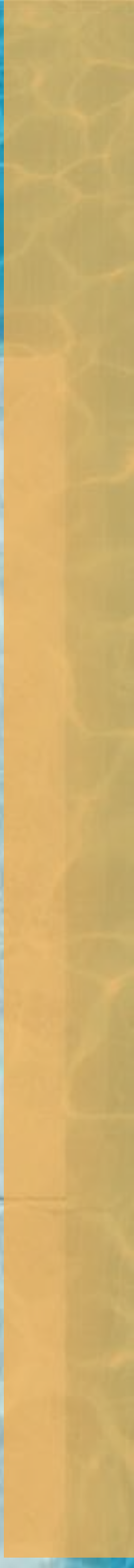

COLORS

PORCELAIN COPINGS

Our porcelain copings can be custom-made in any color

DARK GREY



12"x72"x2"

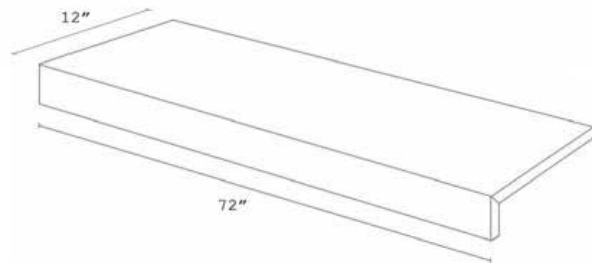

LIGHT GREY



12"x72"x2"

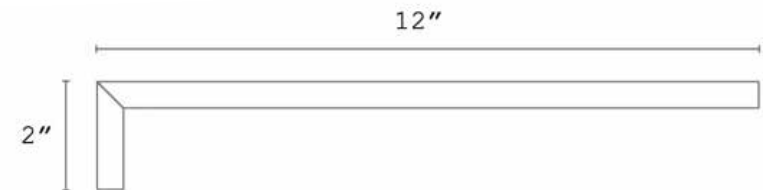

HONEY



13"x24"x3/4"



MILK



13"x24"x3/4"





IN STOCK
DARK GREY



IN STOCK
LIGHT GREY



IN STOCK
LIGHT GREY



COLORS

24"X48"

LIGHT GREY



24"x48"

DARK GREY

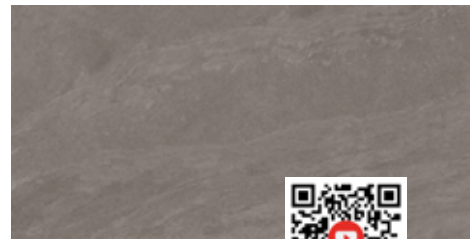

24"x48"

SLATE



24"x48"

IN STOCK IN ITALY

TAUPE



24"x48"

IN STOCK IN ITALY

STORM



24"x48"

CARMEL



24"x48"

MILK



24"x48"

HONEY



24"x48"

ROMANTIC WHITE



24"x48"

ROMANTIC BEIGE



24"x48"

URBAN WHITE



24"x48"

BASALTO GREY



24"x48"

IN STOCK IN ITALY

BASALTO RED



24"x48"

IN STOCK IN ITALY

BASALTO BLACK



24"x48"

IN STOCK IN ITALY

NEST



24"x48"

BURNT



24"x48"

ROCKY



24"x48"

FLAKE



24"x48"

PHILLY TAUPE



24"x48"

PHILLY GREY



24"x48"

PHILLY WHITE



24"x48"

PHILLY BEIGE

IN STOCK IN ITALY



24"x48"

KEYSTONE PURE

IN STOCK IN ITALY



24"x48"

KEYSTONE FOG

IN STOCK IN ITALY



24"x48"

LUCE



24"x48"

CHESTNUT VEINCUT



24"x48"

PEARL VEINCUT

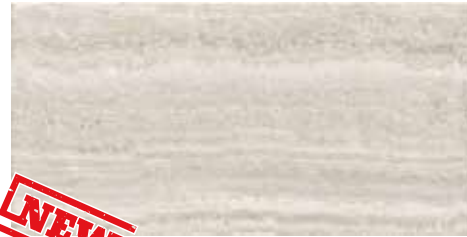

24"x48"

PLATINUM VEINCUT



24"x48"

ARIA



24"x48"





Broil King

REGAL

ROMANTIC WHITE

COLORS

24"X72" & 32"X72"

DARK GREY



24"x72"

LIGHT GREY



24"x72"

CHESTNUT VEINCUT

IN STOCK IN ITALY



NEW

32"x72"

PEARL VEINCUT

IN STOCK IN ITALY



NEW

32"x72"

PLATINUM VEINCUT

IN STOCK IN ITALY



NEW

32"x72"



PEARL VEINCUT

COLORS

48"X48"

ASPEN WHITE

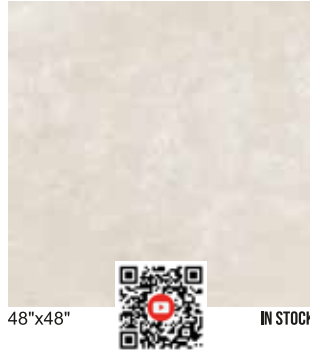

VOLCANO GREY



ASPEN GREY



ASPEN SMOKE



KHROMA TALCO



KHROMA AVORIO



KHROMA KORDA



KHROMA FANGO



KEYSTONE FOSSIL



KEYSTONE PURE



KEYSTONE ROPE



KHROMA FANGO



ASPEN WHITE

COLORS

3CM PORCELAIN PAVERS

BLUESTONE DARK



16"x32" - **IN STOCK**,
24"x24"

BLUESTONE GREY

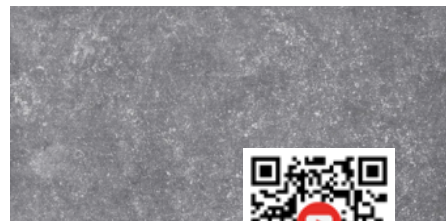

16"x32" - **IN STOCK**,
24"x24", 36"x36"

PIETRA BARGE

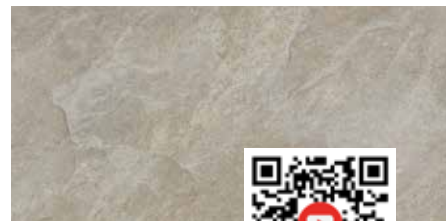

16"x32" - **IN STOCK**,
24"x24"

GRANITO DIORITE



16"x32"

GRANITO MONTORFANO



16"x16", 16"x32", 24"x24", 16"x48"

ZERMATT CHIARO



16"x32"

SLATE BLACK



16"x32", 24"x24"

SLATE GREY



16"x32", 24"x24"

PIETRA BASALTO



16"x32", 24"x24", 36"x36"

PIETRA ANTRAZYT



16"x32"

PIETRA GREY



16"x32"

ZERMATT SCURO



16"x32"

PIETRA OMBRA



16"x32", 24"x24"

PIETRA GRIGIONI

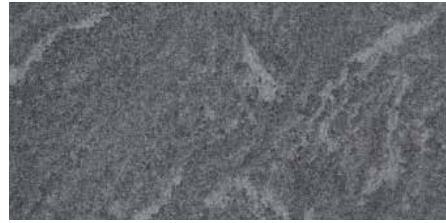

16"x32", 24"x24"

FORESTA SCURO



16"x32"

FORESTA CHIARO



16"x32"



BLUESTONE GREY

COLORS

5 CM ULTRA THICK PORCELAIN PAVERS

These sizes can be purchased individually, allowing for both patterned and single-size selections.

GOLDEN BUFF



NEW

4"x4" - with spacers, 4"x8" - with spacers, 8"x8" - with spacers
8"x16" - no spacers, 16"x24" - no spacers, 24"x24" - no spacers

MISTY BLUE



NEW

4"x4" - with spacers, 4"x8" - with spacers, 8"x8" - with spacers
8"x16" - no spacers, 16"x24" - no spacers, 24"x24" - no spacers

BASALTO



NEW

4"x4" - with spacers, 4"x8" - with spacers, 8"x8" - with spacers
8"x16" - no spacers, 16"x24" - no spacers, 24"x24" - no spacers



GOLDEN BUFF

SCARLET ROCK



NEW

4"x4" - with spacers, 4"x8" - with spacers, 8"x8" - with spacers
8"x16" - no spacers, 16"x24" - no spacers, 24"x24" - no spacers

STORMY ASH



NEW

4"x4" - with spacers, 4"x8" - with spacers, 8"x8" - with spacers
8"x16" - no spacers, 16"x24" - no spacers, 24"x24" - no spacers

AVAILABLE PATTERN OPTIONS

COLORS

MISTY BLUE



1 pc - 4"x4", 2 pcs - 4"x8", 1 pc 8"x8"

STORMY ASH



1 pc - 4"x4", 4 pcs - 4"x8"

BASALTO



1 pc - 4"x4", 2 pcs - 4"x8", 1 pc 8"x8"

SCARLET ROCK



2 pcs- 4"x4", 1 pc - 4"x8", 1 pc 8"x8"

GOLDEN BUFF



1 pc - 4"x4", 1 pc - 4"x8", 1 pc 8"x8"



SPACER



NO SPACER

COLORS

3-D WOOD LOOK PANELS 24"X48" 1 1/32" THICK

HONEY



24"x48"

NEW

HONEY BLACK



24"x48"

NEW

BLACK WALNUT



24"x48"

NEW

ECRU



24"x48"

NEW

ECRU BLACK



24"x48"

NEW





CLAY

3D PORCELAIN LEDGER

BEIGE



6"x8"x4"



6"x24"

TAUPE



6"x8"x4"



6"x24"

GREY



6"x8"x4"



6"x24"

DARK



6"x8"x4"



6"x24"

WHITE



6"x8"x4"



6"x24"

INSIDE CORNER



6"x8"x4"

SPECIAL ORDER

EQ PEDESTALS & ACCESSORY

IN-STOCK

100%
MADE IN ITALY

- QUICK WATER DRAINAGE
- BETTER THERMAL INSULATION



HEIGHT	EQ3	EQ4	EQ5	EQ6	EQ7
	1 1/7" - 1 3/4"	1 2/3" - 2 5/6"	2 3/4" - 5"	4 7/8" - 9 2/9"	7 1/4" - 13 5/9"



Power Key Ambientata T



EQ Key



EQ Lucky Shims



Red EQ Slope Adjuster



ADVANTAGES:

- EASY INSTALLATION
- EXCELLENT FOR HIDING AND EQUIPMENT
- ALWAYS A FLAT PAVING AND EASILY ACCESSIBLE
- EXCELLENT ABSORPTION OF STRUCTURAL MOVEMENT
- BETTER ACOUSTIC INSULATION
- HIGHLY RESISTANCE
- SIGNIFICANT LESS WEIGHT



NEW

ELEGANCE WIND-UP LIFT SYSTEM



NEW

ELEGANCE RAIL SYSTEM



NEW

ELEGANCE SHOCK PROOF STICKER

ADJUSTABLE PEDESTALS & ACCESSORY

IN-STOCK

ADVANTAGES:

- EASY INSTALLATION
- EXCELLENT FOR HIDING AND EQUIPMENT
- ALWAYS A FLAT PAVING AND EASILY ACCESSIBLE
- EXCELLENT ABSORPTION OF STRUCTURAL MOVEMENT
- BETTER ACOUSTIC INSULATION
- HIGHLY RESISTANCE
- SIGNIFICANT LESS WEIGHT
- QUICK WATER DRAINAGE
- BETTER THERMAL INSULATION

PEDCORRECTOR -
Base slope corrector
(0%-5% slope adjustable)



	E3	E4	E5	E6	E6.5	E7
HEIGHT	1 1/8" - 1 5/8"	1 9/16" - 2 9/16"	2 3/8" - 4 1/8"	3 1/2" - 7"	7 1/2" - 11"	7" - 12 5/8"
BREAKING LOAD	1200 lbs	1500 lbs	2250 lbs	1450 lbs	1800 lbs	2400 lbs
COMPOSITION	1 base + 1 head (72 pcs/bx) 1 Spacer Tab (400 pcs/bx) 1 Shim (500 pcs/bx)	1 base + 1 head (54 pcs/bx) 1 Spacer Tab (400 pcs/bx) 1 Shim (500 pcs/bx)	1 base + 1 head (48 pcs/bx) 1 Spacer Tab (400 pcs/bx) 1 Shim (500 pcs/bx)	1 base + 1 head (40 pcs/bx) 1 Spacer Tab (400 pcs/bx) 1 Shim (500 pcs/bx)	1 base (48 pcs/bx) 1 head (36 pcs/bx) 1 Spacer Tab (400 pcs/bx) 1 Shim (500 pcs/bx)	1 base (48 pcs/bx) 1 extender (60 pcs/bx) 1 head (72 pcs/bx) 1 Spacer Tab (400 pcs/bx) 1 Shim (500 pcs/bx)

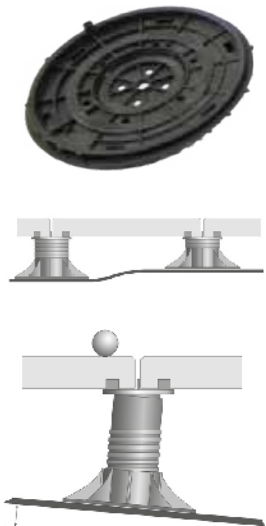



Steel Clips for top and botom

NEW



Wall side Perimeter Plastic Spacer

ADJUSTABLE HEIGHT:

We have a solution height from 1/8" to 50".

MATERIAL:

Polypropylene(PP), material thickness 4.5mm-6mm;
Composition 90% PP, 10% talc, UV and black masterbatch
100% recyclable

DIMENSIONS:

Head=diameter 5 7/8" - surface area 27.28 sq.inch
Base=diameter 7 7/8" - ground surface 48.83 sq.inch
Extender-extender diameter 4 3/4" - adjustable height

PERFORMANCE:

Resisting UV rays, weather, sea salt and almost all chemicals.
Temperature range: -40°F to +248°F (-40°C to +120°C).

APPLICATION:

Support for outdoor terraces with any kind of material: timber decking, stone, ceramic, composite material, metal, fiberglass grid ... Can be placed on any stable substrate, also over insulation panels.

SLOPE CORRECTOR FROM 0%-5% :

Slope correctors could compensate ground fall 0%-5%, making ideal levelling surface. It is assembled on the bottom of pedestals. Clients could choose to use it or not with different installing condition.

FIX COLLAR: Fix and lock height after adjustment, increase stability

SHIM: Anti-slip, reduce impact, absorb shock, compensate floor thickness difference.



Fireproof Steel Pedestal

NEW



RISE-IT



APPLICATIONS:

- ROOFTOPS
- TERRACES & DECKS
- PATIOS
- BALCONIES, VERANDAS & PORCHES
- AROUND SWIMMING POOLS
- BETTER THERMAL INSULATION

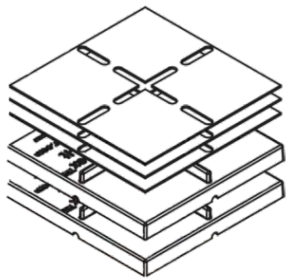

Risers can be stacked 3 pcs high with an elevation of 1/2" increments. Up to 4 shims can be used in conjunction in 1/16" increments for optimal levelling.

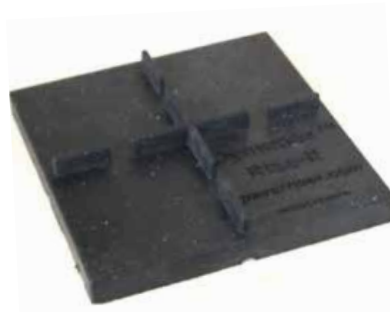

Rise-it 1/2"



Rise-it Shim 1/16"

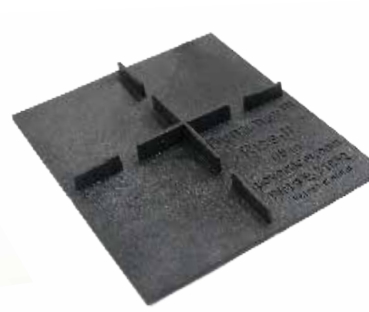

Rise-it 1/8"



Rise-it Flat Top

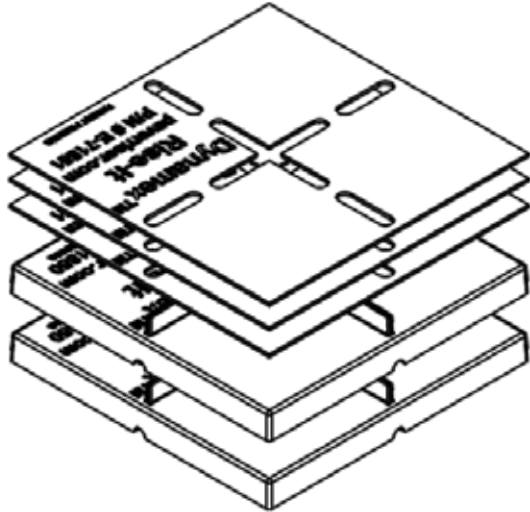
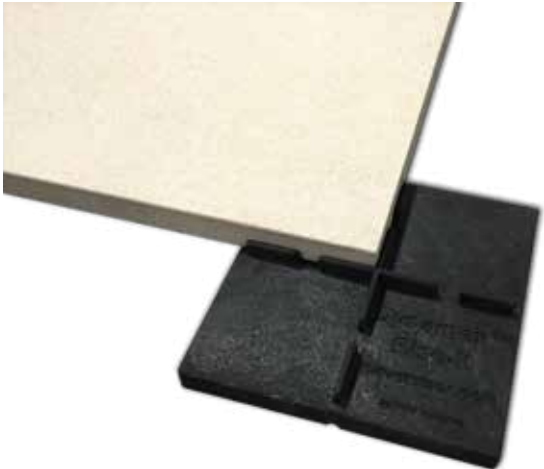



DRY INSTALLATION ON GRAVEL

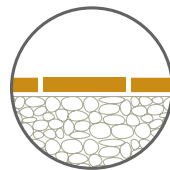

THIS TYPE OF INSTALLATION IS RECOMMENDED FOR WALKABLE FLOORS.

PORCELAIN 2CM PAVER IS INSTALLED ON THE SUBSTRATE WITHOUT USING ADHESIVES OR FILLERS, THEREBY

CREATING WALKWAYS THAT CAN BE WALKED ON IMMEDIATELY. INTEGRATED AND ENVIRONMENTALLY-FRIENDLY.

INSTALLATION ON GRAVEL HAS THE ADVANTAGE OF ALLOWING THE DRAINAGE OF RAINWATER.

INSTALLATION INSTRUCTIONS

- ∞ LEVEL THE GRAVEL
- ∞ POSITION THE TILE
- ∞ USE CROSS SPACERS





INSTALLATION ON SAND IS PARTICULARLY SUITABLE FOR BEACHES AND LIDOS (ESPECIALLY IN LIGHT COLOURS).

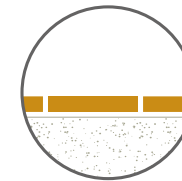

DRY INSTALLATION ON SAND



INSTALLATION INSTRUCTIONS

- ∞ LEVEL THE GRAVEL
- ∞ POSITION THE TILE
- ∞ USE CROSS SPACERS





DRY INSTALLATION ON GRASS

INSTALLATION INSTRUCTIONS

- ∞ LAY THE TILES BY SPACING THEM DEPENDING ON THE DESIRED AESTHETIC EFFECT AND REMOVE THE GRASSY SURFACE
- ∞ SPILL THE GRAVEL AND SAND STABILISER TO IMPROVE THE TIGHTNESS OF THE SUBSTRATE
- ∞ POSITION THE TILE







TRADITIONAL INSTALLATION ON SCREEDS *

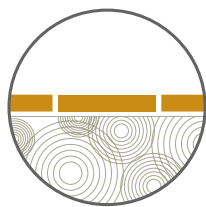

THE EXTRAORDINARY
RESISTANCE OF THIS 20
MM FINE PORCELAIN

STONEWARE MEANS
PORCELAIN 2CM
PAVER, LAID WITH

THE TRADITIONAL
TECHNIQUE ON
SCREEDS, IS THE IDEAL

SOLUTION ALSO FOR
PAVING DRIVEWAYS.



PLEASE CHECK THE SUPPORT CAPACITY AND QUALITY OF THE LAYING
SURFACE BEFORE INSTALLING THE TILES.
LASTLY, A MINIMUM SLOPE IS ADVISED OF 1.5%.

INSTALLATION INSTRUCTIONS

- ∞ SPREAD THE ADHESIVE EVENLY USING THE DOUBLE COATING TECHNIQUE (BOTH ON THE SUBSTRATE AND ON THE BACK OF THE TILE)
- ∞ POSITION THE TILE
- ∞ USE CROSS SPACERS (5 MM JOINTS)
- ∞ GROUT THE FLOOR
- ∞ CLEAN THE SURFACE THOROUGHLY



THIS TYPE OF INSTALLATION REQUIRES OPTIMAL COPLANARITY OF THE SCREED,
DOUBLE LAYER OF ADHESIVE, AND 5 MM JOINTS BETWEEN THE SLABS.

CUSTOM FABRICATION IN TWO WEEKS IN NEW JERSEY

CUSTOM COPINGS & DRAINS



Single Bullnose Coping Project



Double Bullnose Coping Project



Mitered steps and custom drains







IN STOCK
LIGHT GREY

FOR DESIGNERS AND ARCHITECTS

Do Not Miss Your Chance to Get Specified

CADdetails empowers you with high-quality design files presented in an elegant design library. We let you save time and stop losing sales. We streamline the process of architects and designers accessing your products design files and getting specified into projects. Don't be edged out of construction projects because you do not have the right design files in front of the right professionals at the right time. Book a call with us today.

- SELECT DESIRED COLOR:
 HONEY MILK CUSTOM FABRICATION

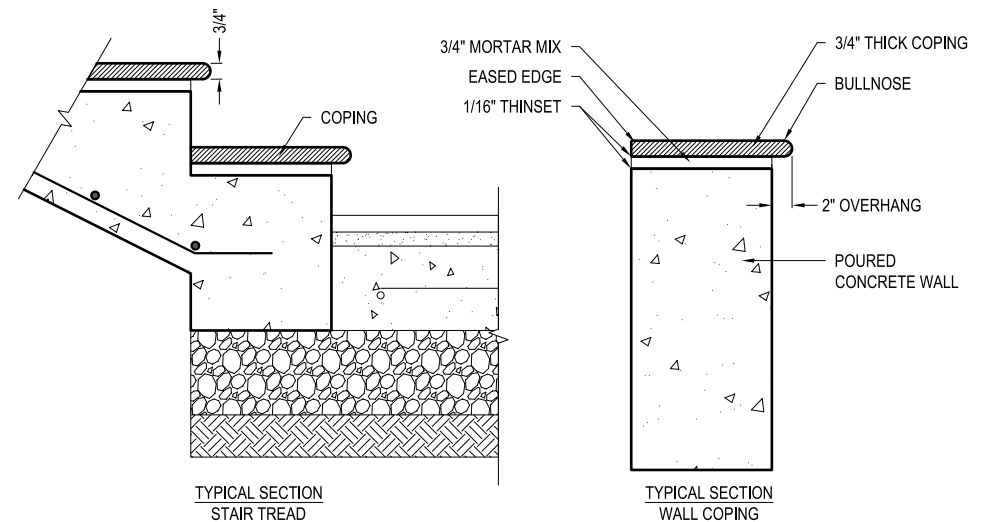

- SELECT DESIRED STONE SIZE (3/4" THICK):
 8" X 48" 16" X 48" 24" X 36" 24" X 48" 40" X 40" 48" X 48"
 20" X 40" 24" X 24" 24" X 72" 32" X 32" 16" X 32"* * ONLY AVAILABLE IN 1 1/4" THICK
- SELECT DESIRED PATTERN:
 3 SIZE MODULAR 4 SIZE MODULAR

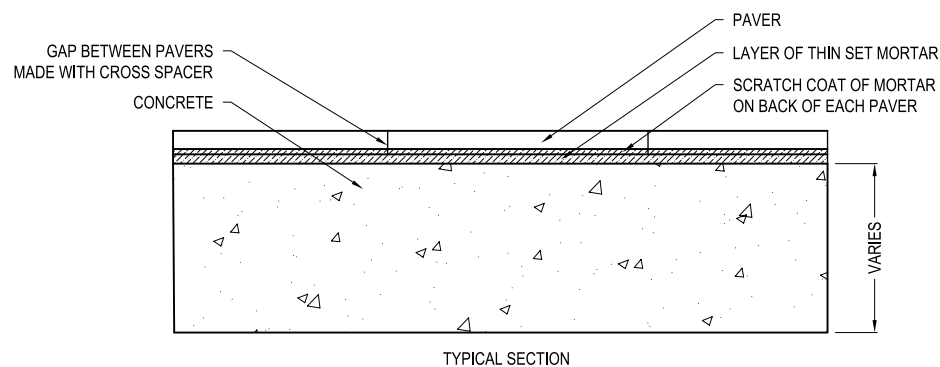

SPECIFICATIONS:
 MATERIAL: PORCELAIN
 STONE SIZE: 13" X 24" X 3/4" (ONE LONG SIDE BULLNOSE AND THE OTHER EASE EDGE)
 SURFACE: ANTI-SLIP (R11)

- NOTES:
 1. DO NOT SCALE DRAWING.
 2. THIS DRAWING IS INTENDED FOR USE BY ARCHITECTS, ENGINEERS, CONTRACTORS, CONSULTANTS AND DESIGN PROFESSIONALS FOR PLANNING PURPOSES ONLY. THIS DRAWING MAY NOT BE USED FOR CONSTRUCTION.
 3. CONTRACTOR'S NOTE: FOR PRODUCT AND COMPANY INFORMATION VISIT www.CADdetails.com/info AND ENTER REFERENCE NUMBER 0000-006.

- MANUFACTURER'S NOTES:
 1. PLEASE SEE MANUFACTURER'S WEBSITE FOR FULL SELECTION OF PORCELAIN PAVER COLOR OPTIONS
 2. 1 SET OF "3 SIZE MODULAR PATTERN" INCLUDES: 1 - 12" X 24" X 3/4", 1 - 24" X 24" X 3/4", 2 - 24" X 36" X 3/4"
 3. 1 SET OF "4 SIZE MODULAR PATTERN" INCLUDES: 3 - 12" X 24" X 3/4", 3 - 18" X 18" X 3/4", 2 - 18" X 36" X 3/4", 2 - 24" X 24" X 3/4"

- NOTES:
 1. DO NOT SCALE DRAWING.
 2. THIS DRAWING IS INTENDED FOR USE BY ARCHITECTS, ENGINEERS, CONTRACTORS, CONSULTANTS AND DESIGN PROFESSIONALS FOR PLANNING PURPOSES ONLY. THIS DRAWING MAY NOT BE USED FOR CONSTRUCTION.
 3. CONTRACTOR'S NOTE: FOR PRODUCT AND COMPANY INFORMATION VISIT www.CADdetails.com/info AND ENTER REFERENCE NUMBER 0000-002.

ELEGANCE

SELECT DESIRED DRILL HOLE OPTION:

STANDARD (SHOWN) CUSTOM ORDER: _____

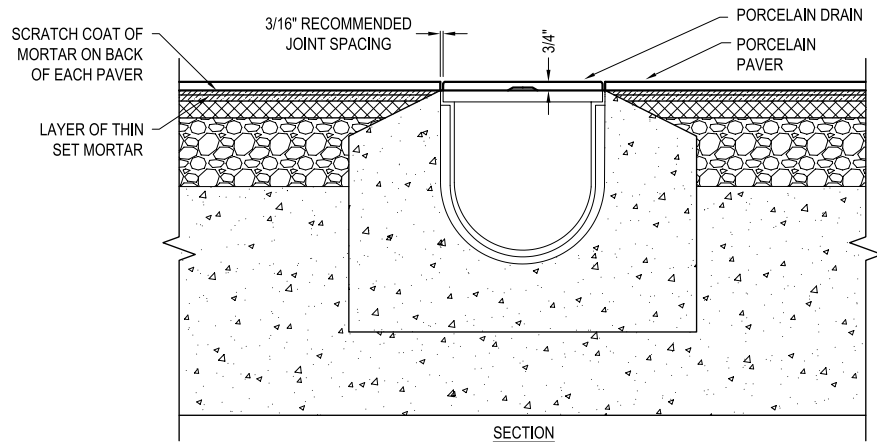
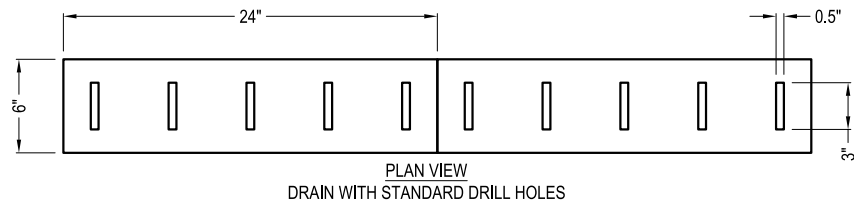

MANUFACTURER'S NOTES:

1. ALL SIZES LISTED ARE NOMINAL

NOTES:

1. DO NOT SCALE DRAWING.
2. THIS DRAWING IS INTENDED FOR USE BY ARCHITECTS, ENGINEERS, CONTRACTORS, CONSULTANTS AND DESIGN PROFESSIONALS FOR PLANNING PURPOSES ONLY. THIS DRAWING MAY NOT BE USED FOR CONSTRUCTION.
3. CONTRACTOR'S NOTE: FOR PRODUCT AND COMPANY INFORMATION VISIT www.CADdetails.com/info AND ENTER REFERENCE NUMBER 5549-011.

SELECT DESIRED COLOR:

DARK GREY LIGHT GREY CUSTOM FABRICATION

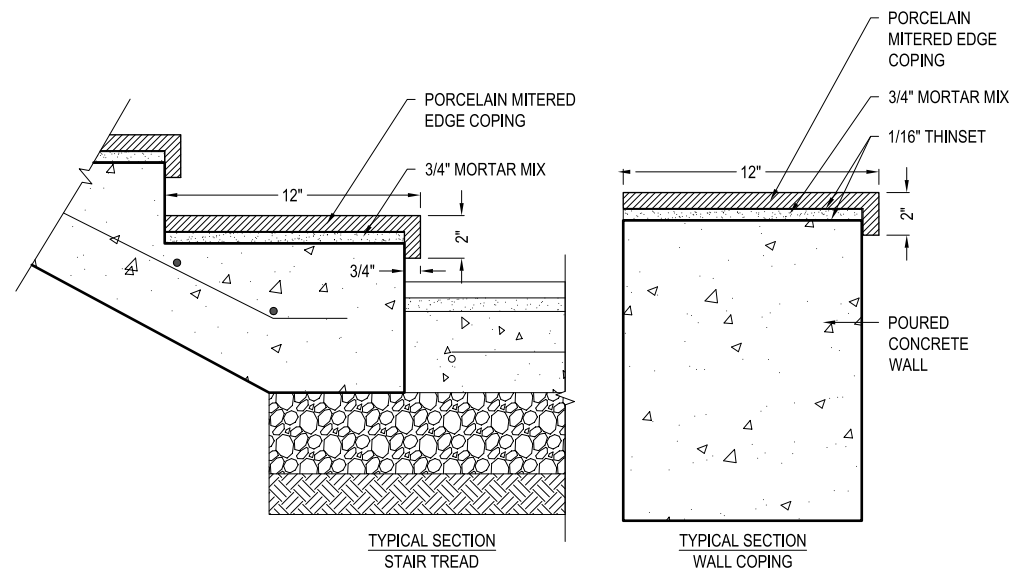

SPECIFICATIONS:

MATERIAL: PORCELAIN

STONE SIZE (MITERED EDGE): 12" X 72" X 3/4" (WITH 2" DROP)

SURFACE: ANTI-SLIP (R11)

MANUFACTURER'S NOTES:

1. ALL SIZES LISTED ARE NOMINAL

NOTES:

1. DO NOT SCALE DRAWING.
2. THIS DRAWING IS INTENDED FOR USE BY ARCHITECTS, ENGINEERS, CONTRACTORS, CONSULTANTS AND DESIGN PROFESSIONALS FOR PLANNING PURPOSES ONLY. THIS DRAWING MAY NOT BE USED FOR CONSTRUCTION.
3. CONTRACTOR'S NOTE: FOR PRODUCT AND COMPANY INFORMATION VISIT www.CADdetails.com/info AND ENTER REFERENCE NUMBER 5549-001.



TO DATE, THERE ARE NO STANDARDS RELATING TO RAISED OUTDOOR FLOORING. THE ONLY STANDARD THAT CAN ACT AS A REFERENCE IS UNI EN 12825, WHICH SPECIFIES THE FEATURES AND PERFORMANCE REQUIREMENTS OF RAISED FLOORINGS MAINLY INTENDED TO BE USED INSIDE BUILDINGS.

PORCELAIN 2CM PAVER MEETS THE REQUIREMENTS OF THIS STANDARD (LISTED IN THE FOLLOWING TABLE).

WITH REGARD TO THE “DYNAMIC LOAD - SHOCK-PROOF TEST AGAINST HARD BODIES”, WE RECOMMEND CHOOSING THE MATERIAL ACCORDING TO THE INTENDED USE AND USING STRUCTURES THAT ARE MAXIMUM 100 MM HIGH.

FINE PORCELAIN STONEWARE

	Technical features	Reference standard or testing method	Value required according to standards	Assessed value
Dimensions and quality of the surface	Length and width (acceptable deviation (%) of the average size of each tile from the manufactured W size)	UNI EN ISO 10545-2	± 0,6 % (± 2,0 mm)	Compliant
	Thickness		± 5 % (± 0,5 mm)	
	Straightness of the edges		± 0,5 % (± 1,5 mm)	Compliant
	Orthogonality		± 0,5 % (± 2,0 mm)	Compliant
	Planarity		± 0,5 % (± 2,0 mm)	
	Surface quality		Minimum 95% of the tested tiles must be free from visible defects	Compliant
Physical properties	Mass of water absorbed	UNI EN ISO 10545-3	Eb ≤ 0,5 %	≤ 0,1 %
	Breaking strength (S) – Flexural resistance (R)	UNI EN ISO 10545-4	S > 1300 N R > 35 N/mm ²	> 10000 N > 45 N/mm ²
	Resistance to frost	UNI EN ISO 10545-12	Request	Compliant
	Deep abrasion resistance	UNI EN ISO 10545-6	≤ 175 mm ³	Compliant
	Resistance to thermal shocks	UNI EN ISO 10545-9	Available test method	Compliant
		UNI EN ISO 10545-8	Available test method	Compliant
	Coefficient of linear thermal dilation	UNI EN ISO 10545-8	Available test method	Compliant
Chemical properties	Resistance to chemical products	UNI EN ISO 10545-13	They must not show relevant signs of chemical attacks	Compliant
	Stain resistance	UNI EN ISO 10545-14	Minimum class 3	Compliant
Safety	Coefficient of kinetic friction	ANSI A 137.1 - DCOF	Wet > 0,42	> 0,42
	Classification □□ non-slip	B.C.R.A.	D.M. μ>0,4	>0,4
		DIN 51130	Depending on the workplace or work area	R11
		DIN 51097	Depending on the wet areas subject to barefoot traffic	A+B+C

With the exception of special pieces and decors

The international reference standards: ISO - EN: The values of the main technical characteristics measured on our products, compared with international standards, are clearly shown and reproduced on our contractual documents (catalogs, price lists, etc.). The values given in this document are common to groups of articles or series of our tiles and therefore are to be used as a guide for a first orientation in choosing the product. If required, the specific values for a given product of a determined supply can be provided depending on its intended use, when formally brought to our attention by notice in writing.

Characteristics and Test methods	Requirements EN 14411 ⁽¹⁾ – G / ISO 13006 ⁽²⁾ - G	Our general values
Determination of water absorption (ISO 10545-3)	Average value E _b ≤ 0,5 % / Individual maximum ≤ 0,6%	≤ 0,03 % Average value and individual maximum
Classification	Definition § 3.2 and § 3.7	BI _a – Porcelain tiles
20 mm Physical properties		Physical properties
Modulus of rupture (ISO 10545-4)	Average ± 35 N/mm ²	≥ 50 N/mm ²
Breaking strength - (ISO 10545-4)	Average ± 1300 N for thickness ≥ 7,5 mm Average ± 700 N for thickness < 7,5 mm	Complies
Flexion resistance and breaking load - (EN 1339-F)		≥ U11 (for square slabs)
P- Averag Breaking Strength	Classes according to EN 1339 - § 5 (3)	≥ 12.000 N (for square slabs)
T - Average of modulus of rupture		≥ 50 N/mm ²
Compressive strength (cubic sample 2 cm side)	NA	≥ 200 N/mm ²
Mohs hardness scale (ex EN 101 / BS 6431-13)	NA	≥ 8
Resistance to surface abrasion - (ISO 10545-7)	Abrasion class and cycles passed	Class 0 – 5
Resistance to deep abrasion (ISO 10545 - 6)	Max volume abraded < 175 / mm ³	< 130 / mm ³
Raccomanded use	Novabell criterion	Class 5 (see Annex N - ISO 13006 / EN 14411)
Color resistance to UV light (DIN 51094)	---	Resistant
Coefficient of linear thermal expansion (ISO 10545-8)	Declared value ⁽¹⁾ / Test method available ⁽²⁾	< 7,1 x 10 ⁻⁶ °C ⁻¹
Thermal shock resistance (ISO 10545-9)	Pass according to EN ISO 10545-1 ⁽¹⁾ / Test method available ⁽²⁾	Complies
Crazing resistance (ISO 10545-11)	Pass according to EN ISO 10545-1 ⁽¹⁾ / Required ⁽²⁾	Complies
Frost resistance (ISO 10545-12)	Pass according to EN ISO 10545-1 ⁽¹⁾ / Required ⁽²⁾	Complies
Moisture expansion (ISO 10545-10)	Declared value ⁽¹⁾ / Test method available ⁽²⁾	≤ 0,1 mm/m
Small colour differences (ISO 10545-16)	D E _{cmc} da < 0,75 a < 1,0 (1)	If agreed
Impact resistance - (ISO 10545-5)	Declared value ⁽¹⁾ / Test method available ⁽²⁾	COR > 0,75
Reaction to fire	Class A1 or A1 _{FL} ⁽¹⁾	A1 _{FL} Classified Without Testing (CWT) – 96/603 EC

20 mm Dimensions and surface quality	Dimensions and surface quality
Dimensions - (ISO 10545-2)	See ANNEX G Complies
Surface quality - (ISO 10545-2 § 7)	A minimum of 95% of the tiles shall be free from visible defects that would impair the appearance of a major area of tiles Complies

(1) Requirements according to EN 14411 (2) Requirements according to ISO 13006 (3) This classification is not an indication of the intended use of NF 187 for concrete slabs

Test methods	Requirements and references	Our general values
DIN 51130	BGR / ASR From R9 to R13	R 11
DIN 51097	GUV-I 8527 A – B – C	A + B + C
BCR - ex BCRA	DM n. 236 / 1989 m > 0,40	m > 0,4
DCOF Resistance (ANSI A 137.1 Section 9.6)	≥ 0,42 ⁽¹⁾	DCOF ≥ 0,42
BS 7679 Pendulum Tester		Wet ≥ 50 Dry ≥ 55

OUTDOOR PORCELAIN PAVER CLEANING GUIDE

AFTER SETTING CLEANING

For the after setting cleaning of a recently installed surface we suggest to use the proper cleaning product according to the type of grout used for the tile joints:

GROUT TYPE	SUGGESTED FABER PRODUCT
Cementitious Grout Residues	CEMENT REMOVER
Epoxy Grout Residues	EPOXY CLEANER

DAILY CLEANING & PERIODIC MAINTENANCE





Specific products for daily cleaning of porcelain ceramic tiles contribute to the beauty and maintenance over the time. Use these solutions with brush, rag or mop. No rinse required.

Daily Cleaning	FLOOR CLEANER
Periodic Maintenance	TILE CLEANER diluted 1:9

EXTRAORDINARY CLEANING AND STAIN REMOVAL

To remove dirt or particular stains from the surface, we suggest the use of a specific detergent if the dirt spreads over the entire surface, while to remove a specific stain or localized residues, proceed with the stain remover.

STAIN / DIRT TYPE	SUGGESTED FABER PRODUCT
Coal	 CEMENT REMOVER
Concrete	
Carbonate efflorescence	
Cement mortar	
Rust	
Colored grout	
Wall paint	

STAIN / DIRT TYPE	SUGGESTED FABER PRODUCT
Plaster	 TILE CLEANER
Superficial patina and detergent residues	
Marks and metallic residues	
Stubborn dirt	
Footprint and haloes	
Coffe	 COLOURED STAIN REMOVER
Wine	
Nicotine	
Marker Pen / Permanent Inks	
Hair Dye	
Ice Cream	 DEEP DEGREASER
Linseed oil	
Animalal or vegetable grease	
Mustard / Mayonese / Ketchup	
Silicone / metallic oils	
Tyre Marks	
Rubber Mark	
Candle Wax	
Protective Wax	
Bituminous Residues	 EPOXY CLEANER
Resin	
Glazes	
Graffiti	
Permanent Inks	
Mastics	
Syntetic Grouts	
Silicon	

PORCELAIN PAVERS PACKAGING INFORMATION						
Group Name	Product Name	Product Size	Quantity In Crate/sq ft	Quantity In Crate/pcs	Weight of Crate/lbs	Dimensions of Crate
20x40	Alpine, Dark, Desert, Dust, Moon, Sand, Silver, Smokey, Sunset, White, Mineral, Fossil, Mars	20"x40"x3/4"	233,3	42 (1pc in a box)	2,150	L42"xD42"xH26"
24x24	Light Grey, Dark Grey, Bluestone Taupe, Inox	24"x24"x3/4"	256	64 (2 pcs in a box)	2,300	L45"xD45"xH29"
	Ash, Coal, Metal, Sandstone	24"x24"x3/4"	240	60 (2 pcs in a box)	2,160	L47"xD31"xH29"
	Soft Cream, Pietra Grey, Rustic Grigio, Pocono, Forge	24"x24"x3/4"	240	60 (2 pcs in a box)	2,160	L47"xD32"xH30"
	Caramel, Honey, Milk, Storm	24"x24"x3/4"	256	64 (2 pcs in a box)	2,300	L45"xD45"xH29"
	Nest, Burnt, Rocky, Flake	24"x24"x3/4"	240	60 (2 pcs in a box)	2,160	L47"xD31"xH29"
	Philly Grey, Philly White, Philly Beige, Philly Taupe	24"x24"x3/4"	256	64 (2 pcs in a box)	2,300	L48"xD32"xH30"
	Urban White, Basalto Grey, Basalto Red, Basalto Black	24"x24"x3/4"	256	64 (2 pcs in a box)	2,300	L45"xD45"xH29"
	Keystone Fog, Keystone Pure	24"x24"x3/4"	256	64 (2 pcs in a box)	2,300	L45"xD45"xH29"
Wood Look	Alpin, Clay, Timber	8"x48"x3/4"	213	80 (2 pcs in a box)	1,920	L48"xD32"xH28"
		16"x48"x3/4"	256	48 (1 pc in a box)	2,304	L51"xD43"xH20"
Cement Look	Antracite, Avorio, Grigio, Inox, Space Dark	32"x32"x3/4"	284,5	40 (1 pc in a box)	2,560	L47"xD37"xH37"
Mini Modular Pattern 3 Sizes	Ash, Coal, Metal, Sandstone	12"x24"x3/4"	240	120 (3 pcs in a box)	2,160	L47"xD31"xH29"
		18"x36"x3/4"	243	54 (2 pcs in a box)	2,200	L47"xD39"xH23"
		24"x24"x3/4"	240	60 (2 pcs in a box)	2,160	L47"xD31"xH29"
24x36	Light Grey, Dark Grey, Bluestone, Urban White, Basalto Grey, Basalto Red, Basalto Black	24"x36"x3/4"	288	48 (1pc in a box)	2,600	L36"xD48"xH22"
Modular Pattern 3 Sizes	Light Grey, Dark Grey, Caramel, Honey, Milk, Storm, Bluestone, Urban White	12"x24"x3/4" 24"x24"x3/4" 24"x36"x3/4"	252	14 Sets	2,200	L48"xD38"xH32"
24"x48"	Light Grey, Dark Grey, Milk, Honey, Storm, Caramel, Slate, Taupe, Romantic White, Romantic Beige, Urban White, Basalto Grey, Basalto Red, Basalto Black	24"x48"x3/4"	256	32 (1 pc in a box)	2,304	L48"xD26"xH24"
	Nest, Burnt, Rocky, Flake	24"x48"x3/4"	280	35 (1 pc in a box)	2,520	L49"xD35"xH30"
	Keystone Fog, Keystone Pure	24"x48"x3/4"	256	32 (1 pc in a box)	2,304	L48"xD26"xH24"
	Philly Grey, Philly White, Philly Beige, Philly Taupe	24"x48"x3/4"	208	26 (1 pc in a box)	2,000	L48"xD32"xH30"
	Platinum Veincut, Pearl Veincut, Chestnut Veincut	24"x48"x3/4"	240	30 pcs (1 pc in a box)	2,210	L48"xD24"xH30"
	Luce, Aria	24"x48"x3/4"	288	36 (1 pc in a box)	2,450	L51"xD40"xH30"
24"x72"	Light Grey, Dark Grey	24"x72"x3/4"	264	22 (1 pc in a box)	2,400	L72"xD36"xH24"
32"x72"	Platinum Veincut, Pearl Veincut, Chestnut Veincut	32"x72"x3/4"	320	20 pcs (1 pc in a box)	2,960	L77"xD40"xH24"
48"x48"	Khroma Talco, Khroma Avorio, Khroma Fango, Khroma Talco, Keystone Pure, Keystone Rope, Keystone Fossil	48"x48"x3/4"	256	16 (1 pc in a box)	2,190	L48"xD48"xH20"
	Aspen White, Volcano Grey, Aspen Grey, Aspen Smoke	48"x48"x3/4"	288	18 (1 pc in a box)	2,600	L48"xD48"xH20"
3-D Wood Look Panels	Ecru, Honey, Ecru Black, Honey Black, Walnut Black	24"x48"x11/32"	256	32 (2 pcs in a box)	1,970	L60"xD32"xH30"
Porcelain Ledger	Taupe, Beige, White, Grey, Dark	6"x24"x3/8"	528	528 (11 pcs in a box)	1,958	L47"xD32"xH30"
		Corner 6"x(8"+4")x3/8"	sold by pcs	48 (6 pcs in a box)		
3cm	Bluestone Dark, Bluestone Grey, Pietra Barge	16"x32"x1 1/4"	192	54 (2 pcs in a box)	2,656	L50"xD32"xH22"
5cm	Basalto, Scarlet Rock, Misty Blue, Golden Buff, Stormy Ash	4"x4"x2"	107	960 pcs/pallet	2,500	L49"xD33"xH26"
		4"x8"x2"	107	480 pcs/pallet	2,500	L49"xD33"xH26"
		8"x8"x2"	107	240 pcs/pallet	2,500	L49"xD33"xH26"
		8"x16"x2"	107	120 pcs/pallet	2,500	L49"xD33"xH26"
		16"x24"x2"	107	40 pcs/pallet	2,500	L49"xD33"xH26"
		24"x24"x2"	112	28 pcs/pallet	2,600	L49"xD25"xH34"
Coping	Dark/Light Grey (Mitered Edge)	12"x72"x2"	180	30 pcs	1,920	L72"xD36"xH22"
	Milk, Honey (1 side bullnose & 1 side eased edge)	13"x24"x3/4"	130	60 pcs (2 pcs in a box)	1,300	L42"xD31"xH25"

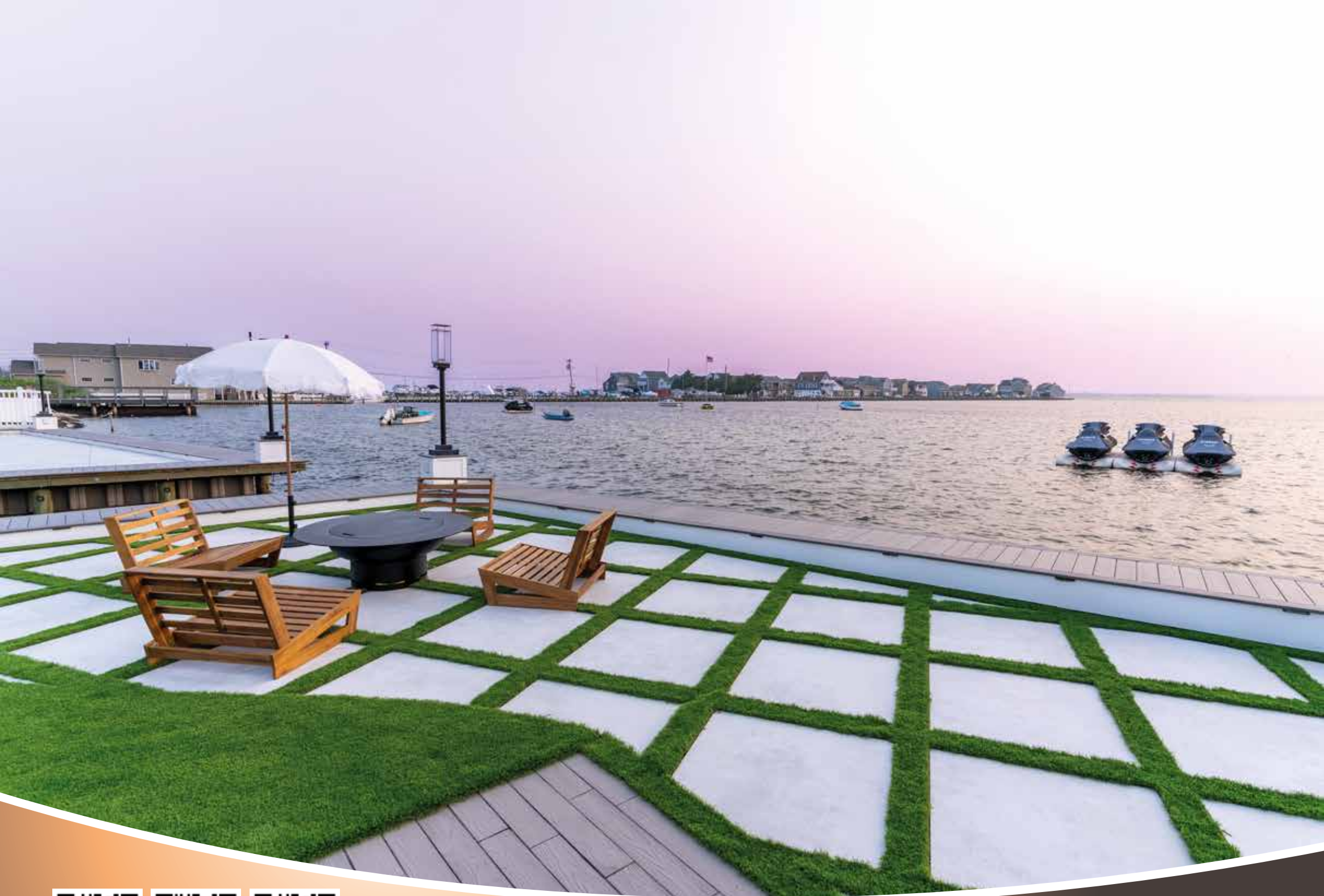

100%
MADE IN ITALY



ISO 9001
ORSA 18001
BUREAU VERITAS
Certification



**RECYCLED
CONTENT**

CE
EN 14411



ATA
Continuing
Education
Provider